

## DS-TMG420 Barrier Gate with Straight Boom Pole



DS-TMG420-X series barrier gate is applicable to entrance and exit management. It is widely used in road toll stations, parking lots, communities, enterprise entrances and exits, etc. to manage the entering and exiting of vehicles and record vehicle passing times. It can be controlled automatically via parking lot management system, or via handle, remote controller, button, etc.

- Adopts integrated machine core. Parallel gear decelerates linkage arm transmission to ensure stability and efficiency.
- Supports convenient side installation with compact structure.
- Adopts quenching process for carbon steel gear to realize wear-resistant and impact-resistant functions and extend product life.
- Adopts small DC brushless motor with low noise to increase output torque and realize precise intelligent control.
- Supports rebound for obstacle and opening priority.
- Adopts DC variable frequency control to enable smooth operation with fast boom pole opening and slow boom pole closing.
- Supports event log to enable convenient monitoring.
- Supports multiple anti-fall modes such as IR, vehicle detectors, and radars.
- Supports fault code detection on the nixie tube, log record, and abundant status indicating. Based on the fault code displayed on the nixie tube, you can realize quickly problems locating and maintenance.
- Supports manually opening boom pole. You can turn hand wheel to keep barrier gate opening during power cutoff.
- Delayed boom pole closing (10 s delay time by default). Supports 99 shifts (initial status 2 s, 2 s gap between each shift).
- Supports auto boom pole opening during power cutoff. The barrier gate can open automatically to allow fire trucks in (optional components required).

## ▪ Specification

Barrier Housing	
Barrier Housing Material	SGCC
Barrier Housing Thickness	1.5 mm
Barrier Housing Door Thickness	1.2 mm
Barrier Housing Color	Iron gray
Barrier Housing Door Color	Orange red
Boom Pole Installation Height	885 mm
Body Indicators	DS-TMG420, DS-TMG420-L, DS-TMG420-R: no body indicator DS-TMG420/B, DS-TMG420-L/B, DS-TMG420-R/B, DS-TMG420/A/B, DS-TMG420-L/A/B, DS-TMG420-R/A/B: with body indicator. Green: arrow indicator. Red: prohibition indicator
Barrier Gate General	
Rising/Falling Speed	3m octagonal pole, right by default, direction switchable Rising Speed: 1.8 S Falling Speed: 1.8 S 4m octagonal pole, right by default, direction switchable Rising Speed: 2.5 S Falling Speed: 2.5 S 6m octagonal pole, right by default, direction switchable Rising Speed: 5 S Falling Speed: 5 S 3m anti-collision round pole, right by default, direction switchable Rising Speed: 1.8 S Falling Speed: 1.8 S 4m anti-collision round pole, right by default, direction switchable Rising Speed: 2.5 S Falling Speed: 2.5 S
Boom Pole Direction	DS-TMG420, DS-TMG420/B, DS-TMG420/A/B: right by default, direction switchable DS-TMG420-L/B, DS-TMG420-L/A/B: Left DS-TMG420-R/B, DS-TMG420-R/A/B: Right
Motor Type	DC brushless motor
Matched Boom Pole Type	Cylinder boom pole: 1 to 4 m, anti-collision Octagonal boom pole: 1 to 6 m Octagonal telescopic boom pole: 4 to 6 m Boom pole ≥ 5 m: with spindle rod
Boom Pole Falling Delay	10 s by default (configurable), min. 2 s (every 2 s followed a gap)
Number of Cycles	5,000,000
Working Voltage	220 VAC
Consumption	DS-TMG420, DS-TMG420-L, DS-TMG420-R: Max. 125 W DS-TMG420/B, DS-TMG420-L/B, DS-TMG420-R/B: Max. 139 W DS-TMG420/A/B, DS-TMG420-L/A/B, DS-TMG420-R/A/B: Max. 155 W
Temperature and Humidity	Temperature: -30 °C to 60 °C (-22 °F to 140 °F), Humidity: ≤ 90%
Rising Boom Pole for Poweroff	Optional, not supported by default

<b>Package</b>	
Barrier Housing Dimensions (L × W × H)	1060 × 370 × 262 mm (41.73 × 14.57 × 10.31 inch)
Body Weight	43 ± 3 kg (94.8 ± 6.61 lb.)
Body Dimensions (with Package, Without Boom Pole) (L × W × H)	1266 × 504 × 626 mm (49.84 × 19.84 × 24.65 inch)
Body Weight (with Package, Without Boom Pole)	47 ± 3 kg (103.61 ± 6.61 lb.)
<b>Barrier Gate</b>	
Duty Cycle	100%
<b>Interface</b>	
RS-485	1 group
Rising to Limit	1 group
Falling to Limit	1 group
Open	1 group
Close	1 group
Stop	1 group
IR/Vehicle Detector/Radar	1 group
Traffic Signal Light	1 group, external power supply required, max. 220 VAC supported
<b>Approval</b>	
RF	CE-RED EN 300220-1 V3.1.1 EN 300220-2 V3.1.1 EN 301489-1 V2.2.3 EN 301489-3 V2.1.1 EN IEC 62311: 2020
EMC	CE-EMC: EN 55032: 2015/A11: 2020 + A1: 2020, EN IEC 61000-3-2: 2019/A1: 2021, EN 61000-3-3: 2013 + A1: 2019/A2: 2021, EN 50130-4: 2011 + A1: 2014
Security	CE-LVD: EN 62368-1: 2014/A11: 2017 CB: IEC 62368-1: 2014 IEC 62368-1: 2018
Environment	ROHS
Protection	IP54, IK09
<b>Boom Pole</b>	
Boom Pole Color	White background with red bar

<p>Boom Pole Weight</p>	<p>2 m octagonal boom pole: 2.5 ± 0.3 kg (5.51 ± 0.66 lb.)            3 m octagonal boom pole: 2.8 ± 0.3 kg (6.17 ± 0.66 lb.)            4 m octagonal boom pole: 3.45 ± 0.3 kg (7.60 ± 0.66 lb.)            5 m octagonal boom pole: 5.9 ± 0.3 kg (13.00 ± 0.66 lb.)            6 m octagonal boom pole: 6.8 ± 0.3 kg (15.21 ± 0.66 lb.)            3 m boom pole with LED strip light: 3.4 ± 0.3 kg (7.50 ± 0.66 lb.)            4 m boom pole with LED strip light: 4.4 ± 0.3 kg (9.70 ± 0.66 lb.)            4 m octagonal telescopic boom pole: 4.42 ± 0.3 kg (9.74 ± 0.66 lb.)            5 m octagonal telescopic boom pole: 4.85 ± 0.3 kg (10.69 ± 0.66 lb.)            6 m octagonal telescopic boom pole: 5.65 ± 0.3 kg (12.46 ± 0.66 lb.)            2 m anti-collision round boom pole: 2.5 ± 0.3 kg (5.51 ± 0.66 lb.)            3 m anti-collision round boom pole: 3.5 ± 0.3 kg (7.71 ± 0.66 lb.)            4 m anti-collision round boom pole: 4.5 ± 0.3 kg (9.92 ± 0.66 lb.)</p>
<p>Boom Pole Dimensions (with Package)</p>	<p>2 m octagonal boom pole: 115 × 60 × 2020 mm (4.53 × 2.36 × 79.53 inch)            3 m octagonal boom pole: 115 × 60 × 3020 mm (4.53 × 2.36 × 118.90 inch)            4 m octagonal boom pole: 115 × 60 × 4020 mm (4.53 × 2.36 × 158.27 inch)            5 m octagonal boom pole: 140 × 65 × 5030 mm (5.51 × 2.56 × 198.03 inch)            6 m octagonal boom pole: 140 × 65 × 6030 mm (5.51 × 2.56 × 237.40 inch)            3 m boom pole with LED strip light: 100 × 60 × 3035 mm (3.94 × 2.36 × 120.07 inch)            4 m boom pole with LED strip light: 100 × 60 × 4035 mm (3.94 × 2.36 × 159.45 inch)            4 m octagonal telescopic boom pole: 120 × 51 × 3100 mm (4.72 × 2.01 × 122.05 inch)            5 m octagonal telescopic boom pole: 120 × 51 × 3500 mm (4.72 × 2.01 × 137.80 inch)            6 m octagonal telescopic boom pole: 120 × 51 × 4005 mm (4.72 × 2.01 × 157.68 inch)            2 m anti-collision round boom pole: 90 × 90 × 2030 mm (3.54 × 3.54 × 79.92 inch)            3 m anti-collision round boom pole: 90 × 90 × 3030 mm (3.54 × 3.54 × 119.29 inch)            4 m anti-collision round boom pole: 90 × 90 × 4030 mm (3.54 × 3.54 × 158.66 inch)</p>
<p>Boom Pole Weight (with Package)</p>	<p>2 m octagonal boom pole: 2.37 ± 0.3 kg (5.22 ± 0.66 lb.)            3 m octagonal boom pole: 3.11 ± 0.3 kg (6.86 ± 0.66 lb.)            4 m octagonal boom pole: 3.965 ± 0.3 kg (8.74 ± 0.66 lb.)            5 m octagonal boom pole: 7.01 ± 0.3 kg (15.45 ± 0.66 lb.)            6 m octagonal boom pole: 8.245 ± 0.3 kg (18.18 ± 0.66 lb.)            3 m boom pole with LED strip light: 4.0 ± 0.3 kg (8.82 ± 0.66 lb.)            4 m boom pole with LED strip light: 5.2 ± 0.3 kg (11.46 ± 0.66 lb.)            4 m octagonal telescopic boom pole: 5.11 ± 0.3 kg (11.27 ± 0.66 lb.)            5 m octagonal telescopic boom pole: 6.23 ± 0.3 kg (13.73 ± 0.66 lb.)            6 m octagonal telescopic boom pole: 7.25 ± 0.3 kg (15.98 ± 0.66 lb.)            2 m anti-collision round boom pole: 2.7 ± 0.3 kg (5.95 ± 0.66 lb.)            3 m anti-collision round boom pole: 4.3 ± 0.3 kg (9.48 ± 0.66 lb.)            4 m anti-collision round boom pole: 5.8 ± 0.3 kg (12.79 ± 0.66 lb.)</p>

<p>Color of Boom Pole with LED Strip Light</p>	<p>DS-TMG420, DS-TMG420-L, DS-TMG420-R, DS-TMG420/B, DS-TMG420-L/B, DS-TMG420-R/B: no boom pole with LED strip light  DS-TMG420/A/B, DS-TMG420-L/A/B, DS-TMG420-R/A/B: with boom pole with LED strip light, green indicator for boom pole opening status  Boom pole other status: red indicator  Photometric parameters:  Red: luminous flux 39.44 lm, light effect 17.86 lm/W  Green: luminous flux 107.56 lm, light effect 45.65 lm/W  Working life (lighting time): 5800 h</p>
<p>Boom Pole Dimensions</p>	<p>2 m octagonal boom pole: 98 × 45 × 2000 mm (3.86 × 1.77 × 78.74 inch)  3 m octagonal boom pole: 98 × 45 × 3000 mm (3.86 × 1.77 × 118.11 inch)  4 m octagonal boom pole: 98 × 45 × 4000 mm (3.86 × 1.77 × 157.48 inch)  5 m octagonal boom pole: 119 × 55 × 5000 mm (4.69 × 2.17 × 196.85 inch)  6 m octagonal boom pole: 119 × 55 × 6000 mm (4.69 × 2.17 × 236.22 inch)  3 m boom pole with LED strip light: 95 × 49 × 3013 mm (3.74 × 1.93 × 118.62 inch)  4 m boom pole with LED strip light: 95 × 49 × 4013 mm (3.74 × 1.93 × 157.99 inch)  4 m octagonal telescopic boom pole: 110 × 44 × 2970 mm (4.33 × 1.73 × 116.93 inch)  5 m octagonal telescopic boom pole: 110 × 44 × 3470 mm (4.33 × 1.73 × 136.61 inch)  6 m octagonal telescopic boom pole: 110 × 44 × 6000 mm (4.33 × 1.73 × 236.22 inch)  2 m anti-collision round boom pole: 80 × 80 × 2000 mm (3.15 × 3.15 × 78.74 inch)  3 m anti-collision round boom pole: 80 × 80 × 3000 mm (3.15 × 3.15 × 118.11 inch)  4 m anti-collision round boom pole: 80 × 80 × 4000 mm (3.15 × 3.15 × 157.48 inch)</p>
<p>Boom Pole Material</p>	<p>AL6061</p>

### ▪ Available Model

- DS-TMG420-R(3m octagonal)
- DS-TMG420-L(3m octagonal)
- DS-TMG420-R(4m octagonal)
- DS-TMG420-L(4m octagonal)
- DS-TMG420-R(6m octagonal)
- DS-TMG420-L(6m octagonal)
- DS-TMG420-R/A/B(3m light pole)
- DS-TMG420-L/A/B(3m light pole)
- DS-TMG420-R/A/B(4m light pole)
- DS-TMG420-L/A/B(4m light pole)
- DS-TMG420(3m octagonal)
- DS-TMG420(4m octagonal)
- DS-TMG420(6m octagonal)
- DS-TMG420(3m anti-round)
- DS-TMG420(4m anti-round)

### ▪ Dimension

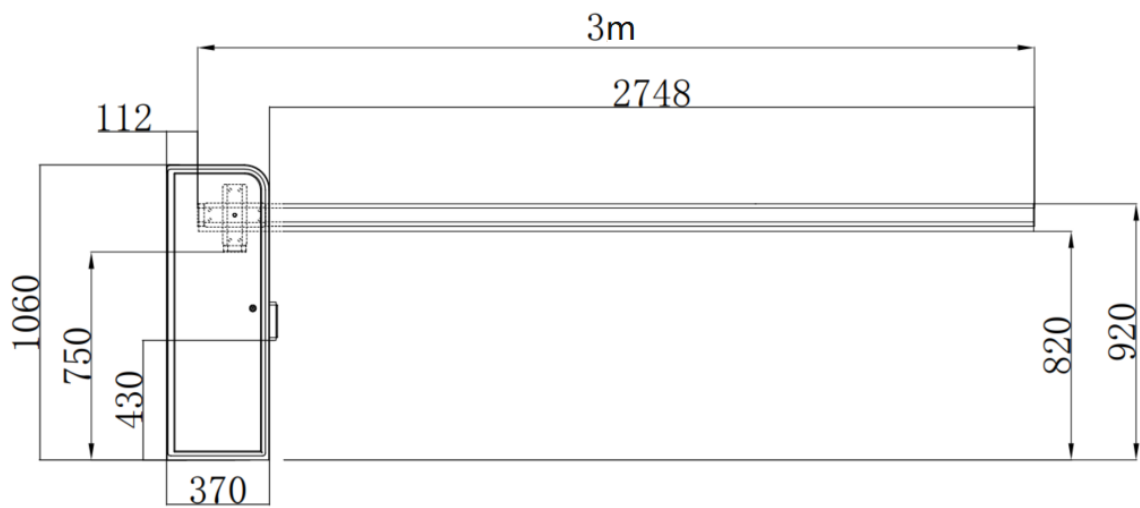
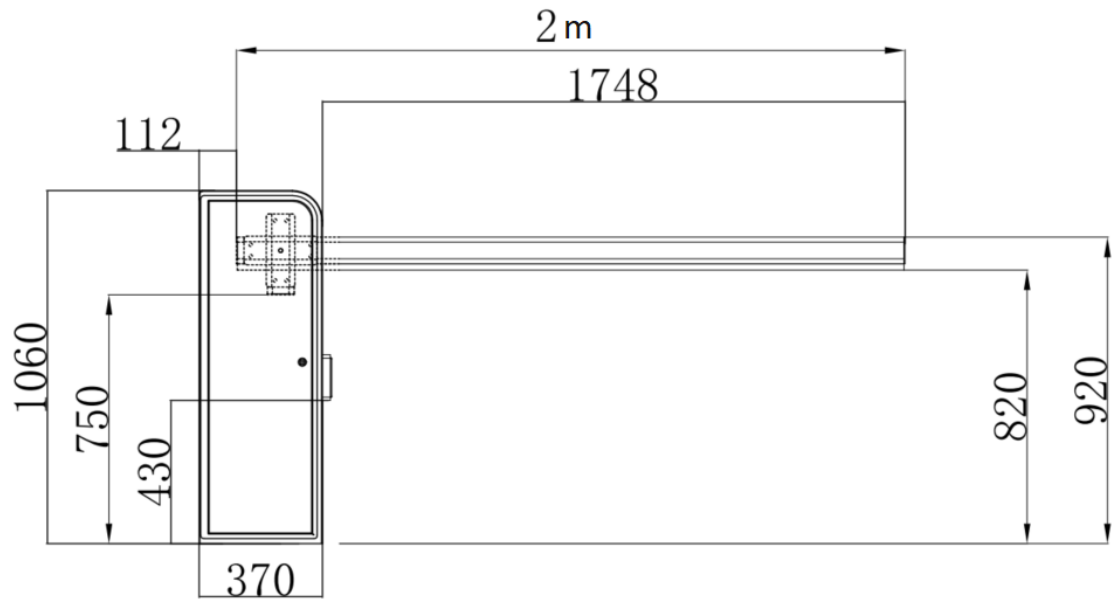

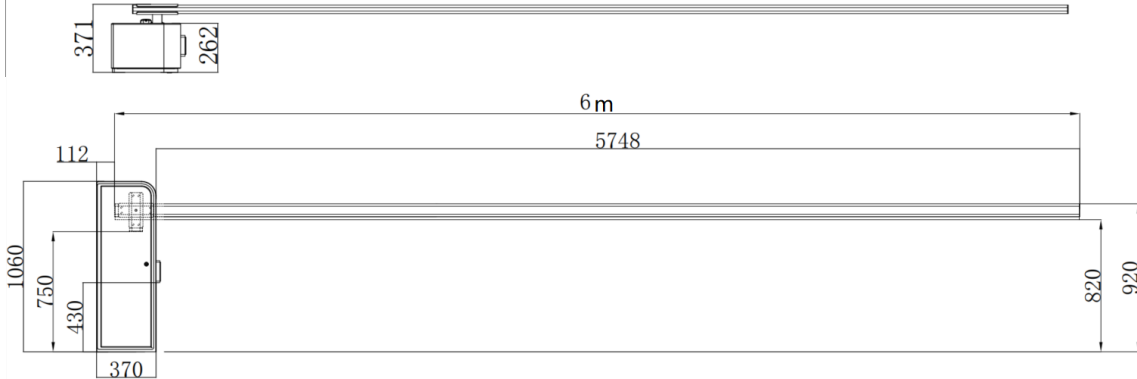
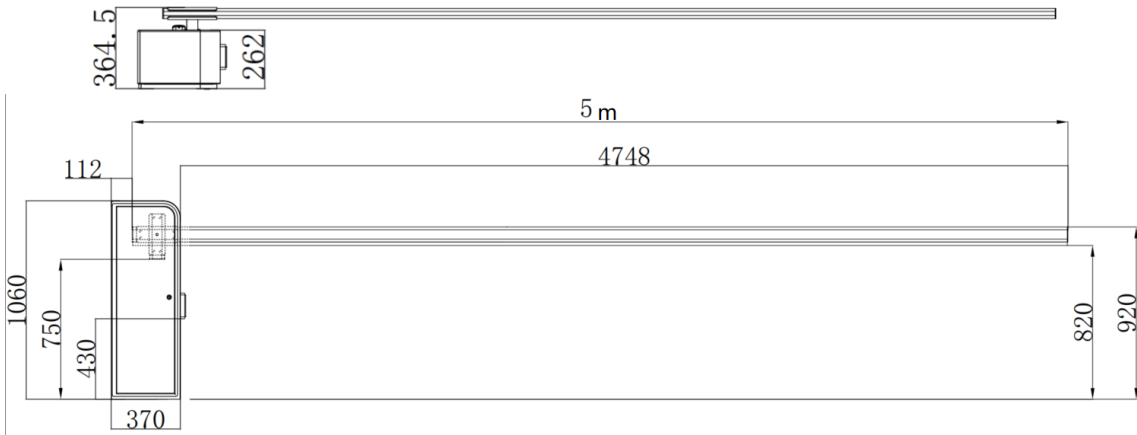
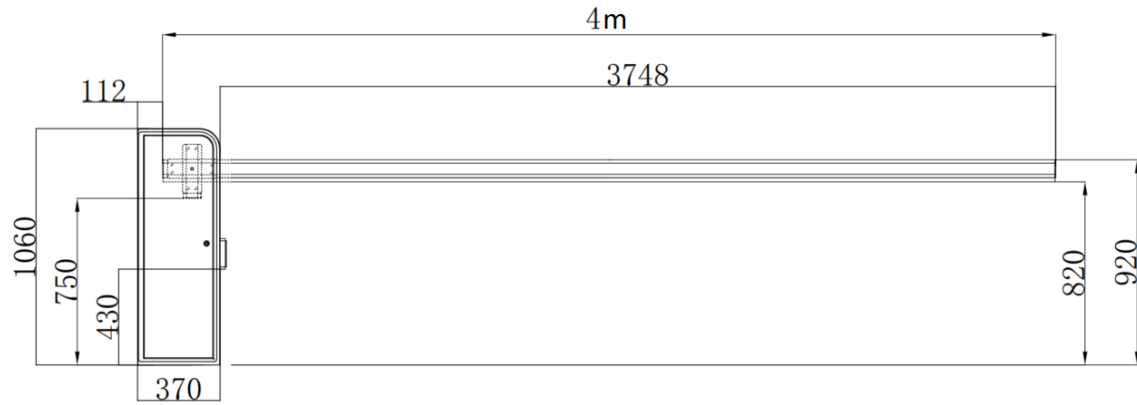







▪ **Accessory**

▪ **Included**

<p><b>DS-TMG001-5</b> Octagonal Straight Boom Pole</p>	<p><b>DS-TMG012-5</b> Remote Controller</p>
	

▪ **Optional**

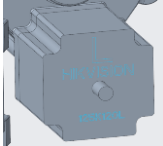
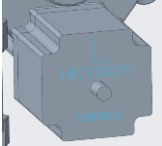
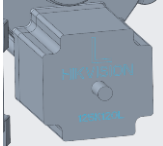
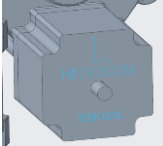
<p><b>EEBracket-L800-1000</b> (barrier) Barrier Pole</p>	<p><b>DS-TMG001-3</b> Straight Pole with Light</p>	<p><b>TMG080-3</b> <b>TMG080-3</b></p>	<p><b>DS-TMG070/4B/42(</b> <b>24V)</b> Barrier Gate Indicator</p>	<p><b>DS-TMG060-42</b> Barrier Gate Supercapacitor Board</p>
				
<p><b>DS-TMG050</b> Pull Rod Antenna Assembly</p>	<p><b>DS-TMG000-2-L</b>(lo w speed)</p>	<p><b>DS-TMG000-2-L</b>(hig h speed)</p>	<p><b>DS-TMG000-2-R</b>(lo w speed)</p>	<p><b>DS-TMG000-2-R</b>(hi gh speed)</p>
				





**Headquarters**

No.555 Qianmo Road, Binjiang District,  
Hangzhou 310051, China  
T +86-571-8807-5998  
www.hikvision.com



Follow us on social media to get the latest product and solution information.

