

Industrial IP67 1-Port Gigabit PoE++ to 2-Port Gigabit PoE++ Repeater

Quick Installation Guide

Packing List

Please check the following items after unpacking, if any missing, please contact your local dealer.

Items	Quantity
Repeater	1 pc
Mounting Accessory	1 set
Quick Installation Guide	1 pc

Product Overview

The product is an Industrial IP67 1-Port Gigabit PoE++ to 2-Port Gigabit PoE++ Repeater, using network cable power supply technology, and can extend 1000Mbps Ethernet signal to 100m and provide 50~57V standard PoE for powered devices.

The repeater is industrial grade, with IP67 waterproof design and wide working temperature -20~65°C. It can withstand harsh environmental tests, and is suitable for security monitoring and network engineering.

Application

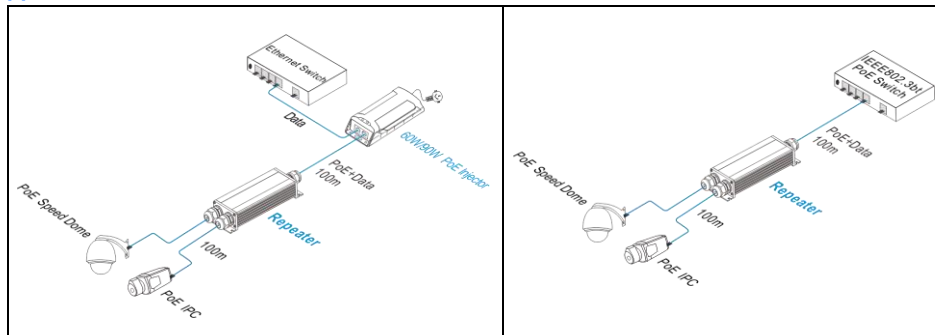

Appearance and Dimensions

Dimensions (mm)

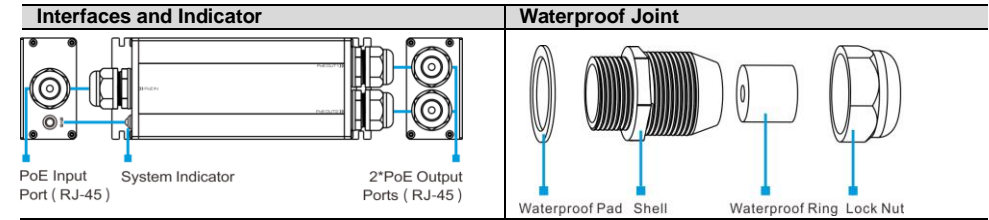
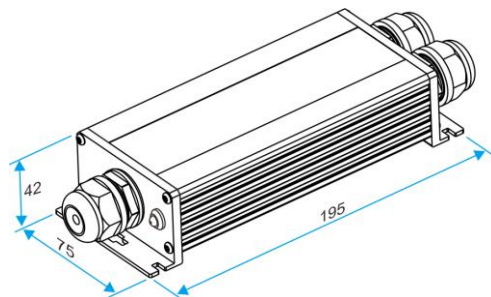

Indicator

The system indicator supports the following 2 states:

State	Descriptions
Off	No power input on the PoE input port.
On (Red)	Normal power input on the PoE input port, but no output power on the PoE output port.
On (Green)	Normal power input on the PoE input port, and normal output power on the PoE output port. No data transfers.
Flashing (Green)	Normal power input on the PoE input port, and normal output power on the PoE output port. And it is transferring data normally.

Installations

Fixing the Cables

Before installation, power off the equipment. Installation when device is powered on is prohibited.

Please use Cat5e or better cables to connect the repeater and the device. Connect the PoE injector or switch to the PoE input port of the repeater. Connect the PoE powered device to the PoE output port of the repeater. Do not reverse it, otherwise the repeater will not work normally.

The waterproof joint allows RJ-45 cables pass through, so that the connector of the repeater can be directly connected to the RJ-45 cable, please follow the steps below.

Step 1: Pass the RJ-45 cable through the waterproof joint.

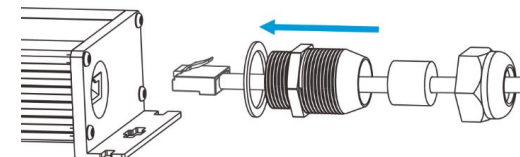

Step 2: Tighten the waterproof connector clockwise.

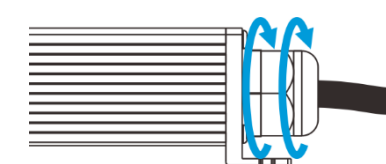

Step 3: Repeat steps 1 and 2 to complete the wiring

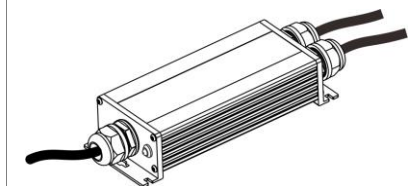

Wall-mounted Installations

This repeater can be mounted to the wall in two ways:

- Fix to the wall with 4 screws.
- Hang to the wall with 2 screws.

Please follow the steps below.

Fix to the wall with 4 screws

Drill 4 holes on the wall where the device is installed. Insert an expansion anchor into each hole drilled in the wall, and beat the top of it with a rubber hammer until all the anchor is inserted into the wall.

Install the device to the wall with 4 screws as the figures below.

Fix to the wall with 4 screws

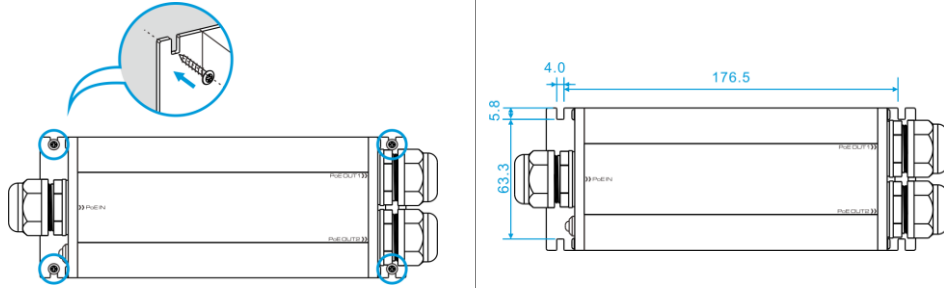

Hang to the wall with 2 screws

Drill 2 holes on the wall where the device is installed. The diameters are as the figures below.

Insert an expansion anchor into each hole drilled in the wall, and beat the top of it with a rubber hammer until all the anchor is inserted into the wall.

Install the device to the wall with 2 screws as the figures below.

Hang to the wall with 2 screws

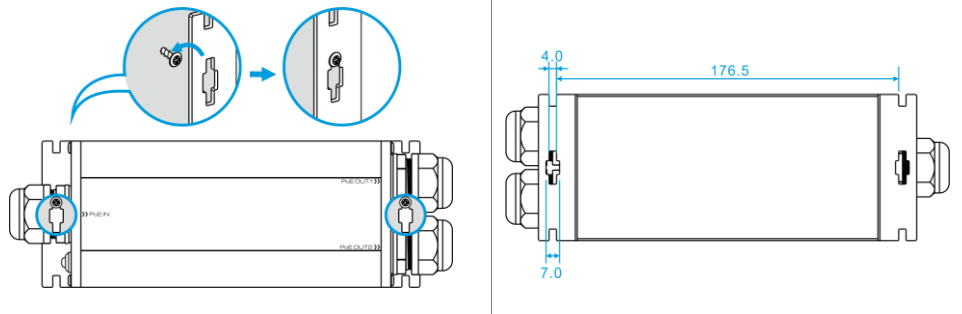

The installation steps are finished.

Caution

- For better transmission performance, it is recommended to use Cat5e or better cables to connect the repeater and the equipment.
- Please connect the PoE input and output ports correctly, otherwise the device will not work normally.
- For better waterproof performance, please make sure the the waterproof joints are tightened.
- When drilling holes in walls make sure not to damage flush-mounted installations like cables or pipes.
- Power on the system only after confirming that the wiring is correct, to avoid damage to the equipment.
- Read the user manual carefully before operating or maintaining the repeater to avoid misoperation.

Specifications

Items	IEEE802.3bt PoE Repeater with 2 output ports (90W)
Ethernet Ports	
PoE Input Port	1*10/100/1000Base-TX RJ-45
PoE Output Port	2*10/100/1000Base-TX RJ-45
PoE	
PoE Standard	IEEE 802.3af/at/bt
PoE Power Supply Type	End-span, Mid-span
PoE Pin Assignment	1/2(-), 3/6(+), 4/5 (+), 7/8 (-)
Input Voltage	50~57V DC, max 90W
Output Power	65W(max)
Switch Property	
Standards	IEEE 802.3, IEEE 802.3u, IEEE 802.3ab
Forwarding Modes	Store and Forward
Transmission Distance	Extend 100m by 1pcs, max. 400m when 3pcs in cascade
MAC Table	8k
Switching Capacity	6Gbps
Packet Forwarding Rate	4.46Mpps
Flow Control	IEEE 802.3x pause frame for full duplex, Back pressure for half duplex
Jumbo Frame	10kB
Environment	
Surge Immunity	6kV, Standard: IEC61000-4-5
ESD Protection	6kV Contact Discharge, 8kV Air Discharge, Standard: IEC61000-4-2
Protection Level	IP67
Operating Temperature	-20°C~65°C
Storage Temperature	-40°C~85°C
Operating Humidity	0~95% (No condensation)
Physical Parameters	
Dimensions (W*D*H)	195mm*75mm*42mm
Net Weight	480g±10g
Material	Metal Shell
Installation	Wall-mounted
Certifications	
Certifications	CE, FCC, RoHS

Version: V1.0, updated 2023-09-11.

The information in this document is subject to change without notice.

Every effort has been made in the preparation of this document to ensure accuracy of the contents, but all statements, information, and recommendations in this document do not constitute a warranty of any kind, express or implied.